



Ministero
dei beni e delle
attività culturali
e del turismo

MINISTERO DEI BENI E DELLE ATTIVITA' CULTURALI
E DEL TURISMO
SOPRINTENDENZA POMPEI



LAVORI DI RESTAURO DEGLI APPARATI DECORATIVI
PARIETALI DALLA VILLA 6 DI CAVA RANIERI IN TERZIGNO (NA)

Progetto definitivo

IL DIRETTORE GENERALE

PROF. MASSIMO OSANNA

IL RESPONSABILE UNICO DEL PROCEDIMENTO:

DOTT.SSA CATERINA CICIRELLI

ELABORATO :

SCHEDE AMBIENTI

S A

IL PROGETTISTA:

DOTT.SSA CATERINA CICIRELLI

PARETI
QUANTIFICAZIONE UNITARIA
AMBIENTE 41

DETTAGLIO MISURE			U.M.	SUPERFICIE PANNELLO	SUPERFICIE AFFRESCO
PANNELLO UNICO	LUNG.	LARG.			
PARETE OVEST - ALCOVA SUD		-	mq	-	
		-		-	
		2,10	1,40	2,94	2,94
			mq	2,94	2,94

DETTAGLIO MISURE			U.M.	SUPERFICIE PANNELLO	SUPERFICIE AFFRESCO
PANNELLO UNICO	LUNG.	LARG.			
PARETE EST		-	mq	-	5,50
		-		-	
		2,50	2,56	6,40	5,50
			mq	6,40	5,50

DETTAGLIO MISURE			U.M.	SUPERFICIE PANNELLO	SUPERFICIE AFFRESCO
PANNELLO UNICO	LUNG.	LARG.			
PARETE SUD		-	mq	-	4,78
		-		-	
		2,28	2,35	5,36	4,78
			mq	5,36	4,78

DETTAGLIO MISURE			U.M.	SUPERFICIE PANNELLO	SUPERFICIE AFFRESCO
PANNELLO UNICO	LUNG.	LARG.			
PARETE OVEST - ALCOVA OVEST		-	mq	-	3,38
		-		-	
		2,32	1,62	3,76	3,38
			mq	3,76	3,38

DETTAGLIO MISURE			U.M.	SUPERFICIE PANNELLO	SUPERFICIE AFFRESCO
PANNELLO UNICO	LUNG.	LARG.			
PARETE SUD- ALCOVA OVEST		-	mq	-	2,61
		-		-	
		1,96	1,58	3,10	2,61
			mq	3,10	2,61

DETTAGLIO MISURE			U.M.	SUPERFICIE PANNELLO	SUPERFICIE AFFRESCO
PANNELLO UNICO	LUNG.	LARG.			
PARETE NORD		-	mq	-	8,18
		-		-	
		-		-	
	3,75	2,18		8,18	8,18
			mq	8,18	8,18
TOTALE AMBIENTE 41			MQ	29,73	27,39

PARETI
QUANTIFICAZIONE UNITARIA
AMBIENTE 42

DETTAGLIO MISURE			U.M.	SUPERFICIE PANNELLO	SUPERFICIE AFFRESCO
PANNELLO UNICO	LUNG.	LARG.			
PARETE SUD		-	mq	-	7,01
		-		-	
		-		-	
	3,29	2,32		7,63	7,01
			mq	7,63	7,01

DETTAGLIO MISURE			U.M.	SUPERFICIE PANNELLO	SUPERFICIE AFFRESCO
PANNELLO UNICO	LUNG.	LARG.			
PARETE OVEST		-	mq	-	3,84
		-		-	
		-		-	
	1,96	2,04		4,00	3,84
			mq	4,00	3,84

DETTAGLIO MISURE			U.M.	SUPERFICIE PANNELLO	SUPERFICIE AFFRESCO
PANNELLO UNICO	LUNG.	LARG.			
PARETE NORD		-	mq	-	5,52
		-		-	
		-		-	
	2,38	2,32		5,52	5,52
			mq	5,52	5,52

DETTAGLIO MISURE			U.M.	SUPERFICIE PANNELLO	SUPERFICIE AFFRESCO
PANNELLO UNICO	LUNG.	LARG.			
PARETE EST - ALCOVA EST		-	mq	-	3,86
		-		-	
		-		-	
	2,24	1,89		4,23	3,86
			mq	4,23	3,86

DETTAGLIO MISURE			U.M.	SUPERFICIE PANNELLO	SUPERFICIE AFFRESCO
PANNELLO UNICO	LUNG.	LARG.			
PARETE NORD - ALCOVA EST		-	mq	-	1,41
		-		-	
	1,42	1,29		1,83	1,41
			mq	1,83	1,41

DETTAGLIO MISURE			U.M.	SUPERFICIE PANNELLO	SUPERFICIE AFFRESCO
PANNELLO UNICO	LUNG.	LARG.			
PARETE EST - ALCOVA NORD		-	mq	-	0,98
		-		-	
	1,14	1,11		1,27	0,98
			mq	1,27	0,98

TOTALE AMBIENTE 42

mq

20,25

17,09

PARETI
QUANTIFICAZIONE UNITARIA
AMBIENTE 25

DETTAGLIO MISURE			U.M.	SUPERFICIE PANNELLO	SUPERFICIE AFFRESCO
PANNELLO UNICO	LUNG.	LARG.			
PARETE OVEST		-	mq	-	17,57
		-		-	
	7,57	2,76		20,89	17,57
			mq	20,89	17,57

DETTAGLIO MISURE			U.M.	SUPERFICIE PANNELLO	SUPERFICIE AFFRESCO
PANNELLO UNICO	LUNG.	LARG.			
PARETE SUD		-	mq	-	7,47
		-		-	
	3,61	2,37		8,56	7,47
			mq	8,56	7,47
TOTALE AMBIENTE 25			mq	29,45	25,04

PARETI
QUANTIFICAZIONE UNITARIA
AMBIENTE 31

DETTAGLIO MISURE			U.M.	SUPERFICIE PANNELLO	SUPERFICIE AFFRESCO
PANNELLO UNICO	LUNG.	LARG.			

	PARETE SUD		-	mq	-	1,50
			-		-	
		1,39	1,08		1,50	1,50
	TOTALE AMBIENTE 31			mq	1,50	1,50

**PARETI
QUANTIFICAZIONE UNITARIA
AMBIENTE 26**

DETTAGLIO MISURE			U.M.	SUPERFICIE PANNELLO	SUPERFICIE AFFRESCO
PANNELLO UNICO	LUNG.	LARG.			
PARETE NORD		-	mq	-	2,44
		-		-	
	1,86	2,00		3,72	2,44
			mq	3,72	2,44

DETTAGLIO MISURE			U.M.	SUPERFICIE PANNELLO	SUPERFICIE AFFRESCO
PANNELLO UNICO	LUNG.	LARG.			
PARETE OVEST		-	mq	-	1,89
		-		-	
	-	1,70	1,45		2,47
			mq	2,47	1,89

DETTAGLIO MISURE			U.M.	SUPERFICIE PANNELLO	SUPERFICIE AFFRESCO
PANNELLO UNICO	LUNG.	LARG.			
PARETE EST (26B)		-	mq	-	3,03
		-		-	
	3,03	1,80		5,45	3,03
			mq	5,45	3,03
	TOTALE AMBIENTE 26			11,64	7,36

**PARETI
QUANTIFICAZIONE UNITARIA
AMBIENTE 28**

DETTAGLIO MISURE			U.M.	SUPERFICIE PANNELLO	SUPERFICIE AFFRESCO
PANNELLO UNICO	LUNG.	LARG.			
PARETE EST					

		1,10	0,845	MQ	0,93	0,88
					0,93	0,88

DETTAGLIO MISURE			U.M.	SUPERFICIE PANNELLO	SUPERFICIE AFFRESCO
PANNELLO UNICO	LUNG.	LARG.			
PARETE OVEST PILASTRO FACCIA NORD					
	1,00	0,50	mq	0,50	0,48
				0,50	0,48

DETTAGLIO MISURE			U.M.	SUPERFICIE PANNELLO	SUPERFICIE AFFRESCO
PANNELLO UNICO	LUNG.	LARG.			
PARETE SUD					
	1,55	0,47		0,73	0,50
			mq	0,73	0,50

DETTAGLIO MISURE			U.M.	SUPERFICIE PANNELLO	SUPERFICIE AFFRESCO
PANNELLO UNICO	LUNG.	LARG.			
PARETE OVEST	0,78	0,91		0,71	
	1,00	0,90		0,90	
	1,45	0,22		0,32	
	-	-		-	-
			mq	1,93	1,48

DETTAGLIO MISURE			U.M.	SUPERFICIE PANNELLO	SUPERFICIE AFFRESCO
PANNELLO UNICO	LUNG.	LARG.			
PARETE NORD	3,53	0,91		3,21	
	-	-		-	
	-	-		-	
	-	-		-	-
			mq	3,21	1,28
SOMMA AMBIENTE 28			mq	7,30	4,62

SCHEDA D'INTERVENTO				
TAGLI / DISTACCHI				
AMBIENTE 41 PARETE OVEST ALCOVA SUD				
DESC.ART.	UM	SUPERFICIE	PREZZO UNITARIO	IMPORTO
045097a	mq	2,94	€ 435,35	€ 1 279,93
045095	mq	2,94	€ 377,98	€ 1 111,26
045096.b	mq	2,94	€ 144,54	€ 424,95
045028.a	mq	2,94	€ 82,66	€ 243,02
045054.b	mq	2,94	€ 577,70	€ 1 698,44
045031.b	mq	2,94	€ 173,03	€ 508,71
045077.b	mq	2,94	€ 123,38	€ 362,74
045083.b	mq	2,94	€ 303,63	€ 892,67
045085.d	mq	2,94	€ 324,55	€ 954,18
045090.b	mq	2,94	€ 24,92	€ 73,26
TOTALE INTERVENTO				€ 7 549,16

Terzigno Villa 6
Ambiente 41 parete Ovest
alcova Sud
SUPERFICIE PANNELLO MQ: 2.94
SUPERFICIE AFFRESCO MQ: 2.94

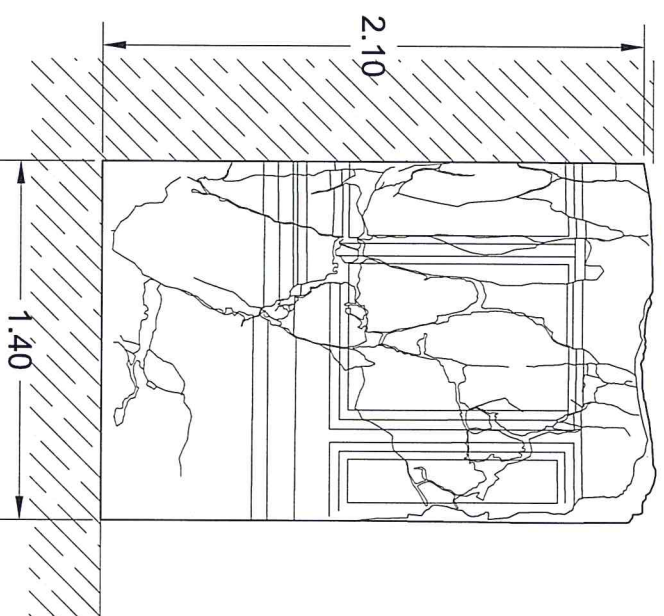
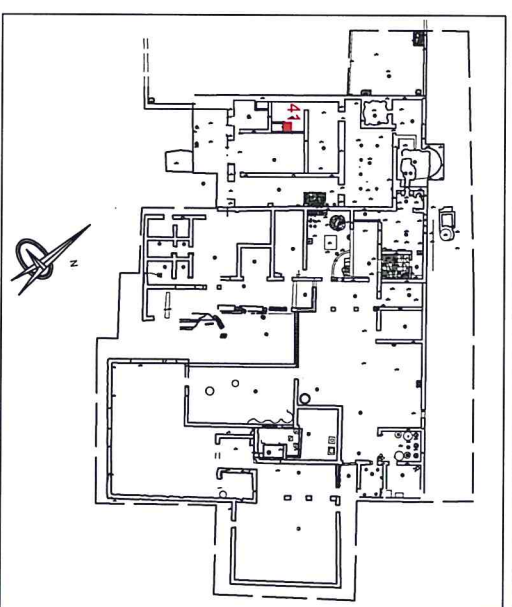

SCHEDA D'INTERVENTO				
TAGLI / DISTACCHI				
AMBIENTE 41 PARETE EST				
DESC.ART.	UM	SUPERFICIE	PREZZO UNITARIO	IMPORTO
045097a	mq	6,40	€ 435,35	€ 2 786,24
045095	mq	5,50	€ 377,98	€ 2 078,89
045096.b	mq	5,50	€ 144,54	€ 794,97
045028.a	mq	5,50	€ 82,66	€ 454,63
045054.b	mq	5,50	€ 577,70	€ 3 177,35
045031.b	mq	5,50	€ 173,03	€ 951,67
045077.b	mq	5,50	€ 123,38	€ 678,59
045083.b	mq	5,50	€ 303,63	€ 1 669,97
045085.d	mq	5,50	€ 324,55	€ 1 785,03
045090.b	mq	5,50	€ 24,92	€ 137,06
TOTALE INTERVENTO				€ 14 514,39

Terzigno Villa 6

Ambiente 41 parete Est

SUPERFICIE PANNELLO MQ: 6.40
SUPERFICIE AFFRESCO MQ: 5.50

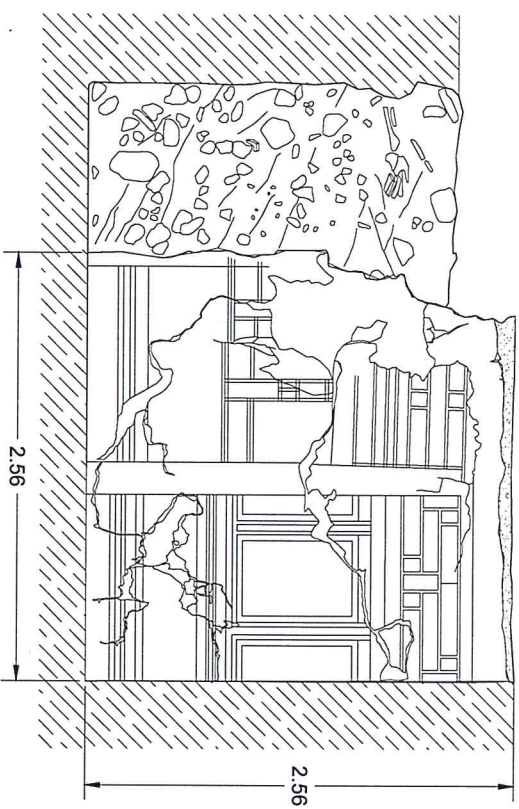
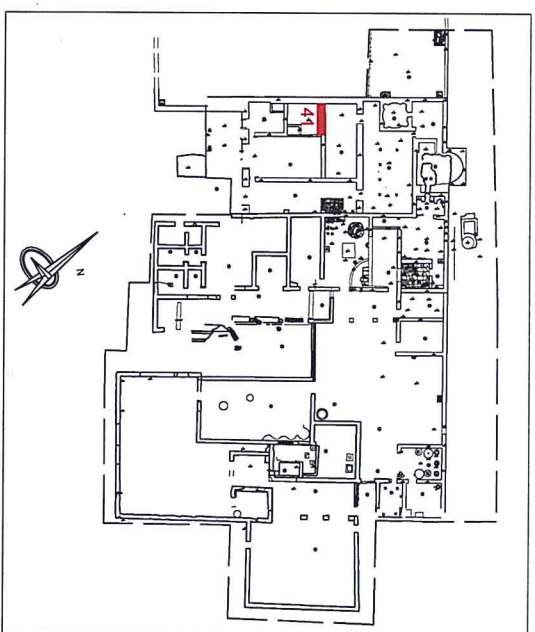

SCHEDA D'INTERVENTO				
TAGLI / DISTACCHI				
AMBIENTE 41 PARETE SUD				
DESC.ART.	UM	SUPERFICIE	PREZZO UNITARIO	IMPORTO
045097a	mq	5,36	€ 435,35	€ 2 333,48
045095	mq	4,78	€ 377,98	€ 1 806,74
045096.b	mq	4,78	€ 144,54	€ 690,90
045028.a	mq	4,78	€ 82,66	€ 395,11
045054.b	mq	4,78	€ 577,70	€ 2 761,41
045031.b	mq	4,78	€ 173,03	€ 827,08
045077.b	mq	4,78	€ 123,38	€ 589,76
045083.b	mq	4,78	€ 303,63	€ 1 451,35
045085.d	mq	4,78	€ 324,55	€ 1 551,35
045090.b	mq	4,78	€ 24,92	€ 119,12
TOTALE INTERVENTO				€ 12 526,30

Terzigno Villa 6
Ambiente 41 parete Sud

SUPERFICIE PANNELLO: MQ 5.36
SUPERFICIE AFFRESCO : MQ 4.78

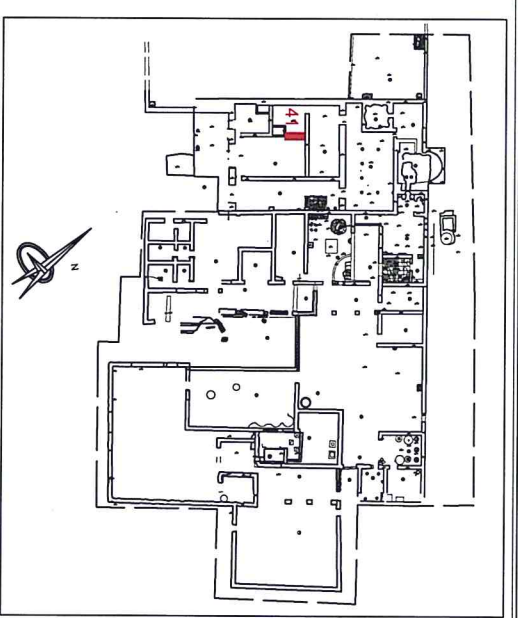

SCHEDA D'INTERVENTO				
TAGLI / DISTACCHI				
AMBIENTE 41 PARETE OVEST - ALCOVA OVEST				
DESC.ART.	UM	SUPERFICIE	PREZZO UNITARIO	IMPORTO
045097a	mq	3,76	€ 435,35	€ 1 636,92
045095	mq	3,38	€ 377,98	€ 1 277,57
045096.b	mq	3,38	€ 144,54	€ 488,55
045028.a	mq	3,38	€ 82,66	€ 279,39
045054.b	mq	3,38	€ 577,70	€ 1 952,63
045031.b	mq	3,38	€ 173,03	€ 584,84
045077.b	mq	3,38	€ 123,38	€ 417,02
045083.b	mq	3,38	€ 303,63	€ 1 026,27
045085.d	mq	3,38	€ 324,55	€ 1 096,98
045090.b	mq	3,38	€ 24,92	€ 84,23
TOTALE INTERVENTO				€ 8 844,39

Terzigno Villa 6
Ambiente 41 parete Ovest
alcova Ovest
SUPERFICIE PANNELLO MQ 3,76
SUPERFICIE AFFRESCO MQ 3.38

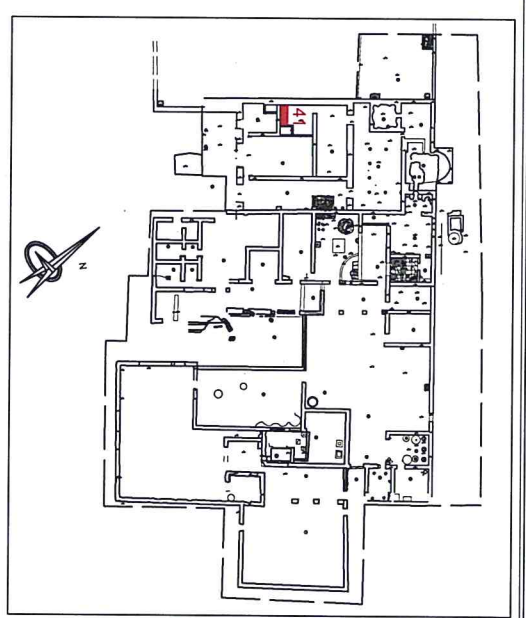
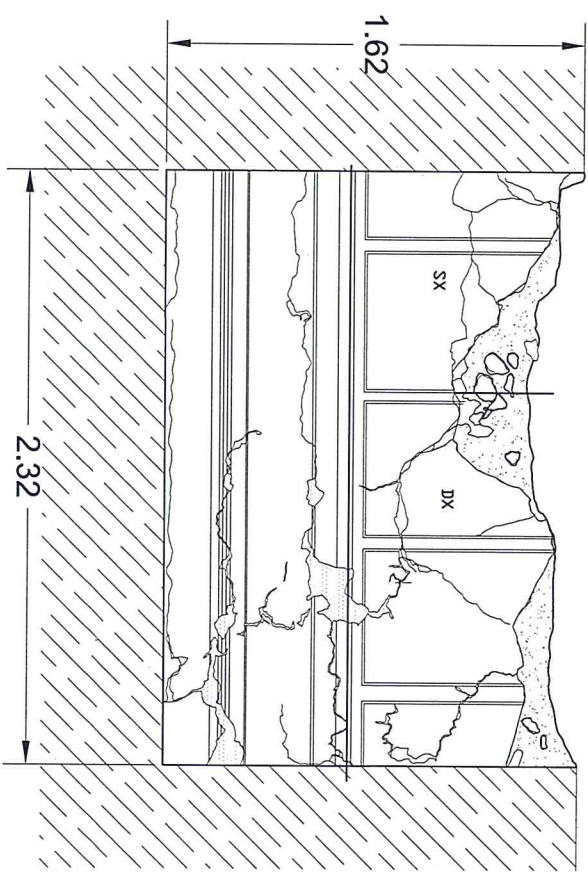

SCHEDA D'INTERVENTO				
TAGLI / DISTACCHI				
AMBIENTE 41 PARETE SUD -ALCOVA OVEST				
DESC.ART.	UM	SUPERFICIE	PREZZO UNITARIO	IMPORTO
045097a	mq	3,10	€ 435,35	€ 1 349,59
045095	mq	2,61	€ 377,98	€ 986,53
045096.b	mq	2,61	€ 144,54	€ 377,25
045028.a	mq	2,61	€ 82,66	€ 215,74
045054.b	mq	2,61	€ 577,70	€ 1 507,80
045031.b	mq	2,61	€ 173,03	€ 451,61
045077.b	mq	2,61	€ 123,38	€ 322,02
045083.b	mq	2,61	€ 303,63	€ 792,47
045085.d	mq	2,61	€ 324,55	€ 847,08
045090.b	mq	2,61	€ 24,92	€ 65,04
TOTALE INTERVENTO				€ 6 915,12

Terzigno Villa 6
Ambiente 41 parete Sud
alcova Ovest

SUPERFICIE PANNELLO: MQ 3.10
SUPERFICIE AFFRESCO : MQ 2.61

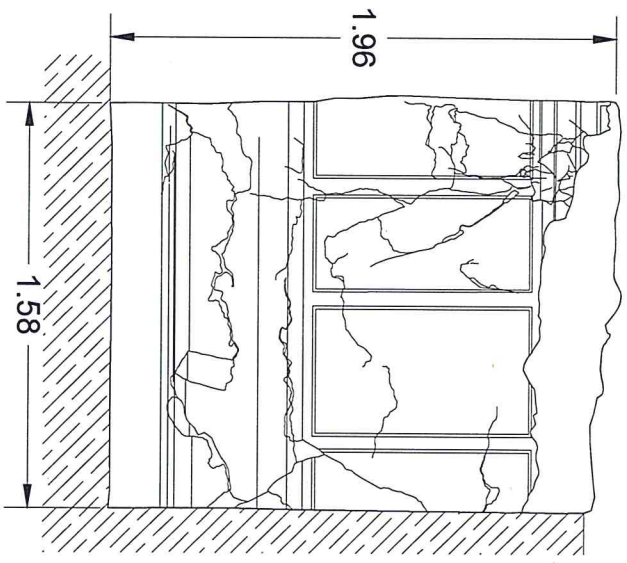
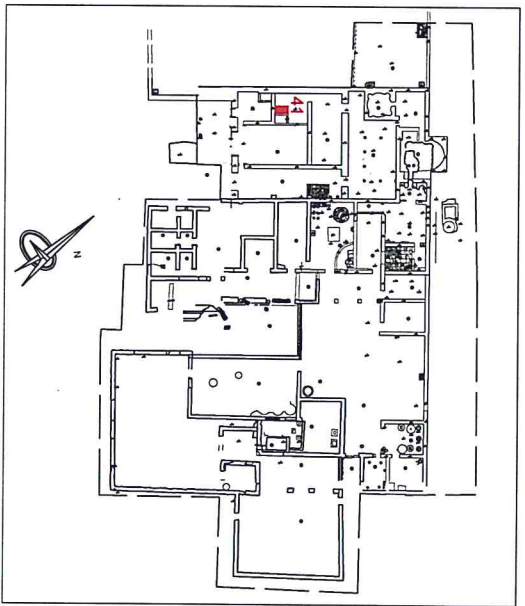

SCHEDA D'INTERVENTO				
TAGLI / DISTACCHI				
AMBIENTE 41 PARETE NORD				
DESC.ART.	UM	SUPERFICIE	PREZZO UNITARIO	IMPORTO
045097a	mq	8,18	€ 435,35	€ 3 561,16
045095	mq	8,18	€ 377,98	€ 3 091,88
045096.b	mq	8,18	€ 144,54	€ 1 182,34
045028.a	mq	8,18	€ 82,66	€ 676,16
045054.b	mq	8,18	€ 577,70	€ 4 725,59
045031.b	mq	8,18	€ 173,03	€ 1 415,39
045077.b	mq	8,18	€ 123,38	€ 1 009,25
045083.b	mq	8,18	€ 303,63	€ 2 483,69
045085.d	mq	8,18	€ 324,55	€ 2 654,82
045090.b	mq	8,18	€ 24,92	€ 203,85
TOTALE INTERVENTO				€ 21 004,11

Terzigno Villa 6

Ambiente 41 parete Nord

SUPERFICIE PANNELLO : MQ 8.18

SUPERFICIE AFFRESCO : MQ 8.18

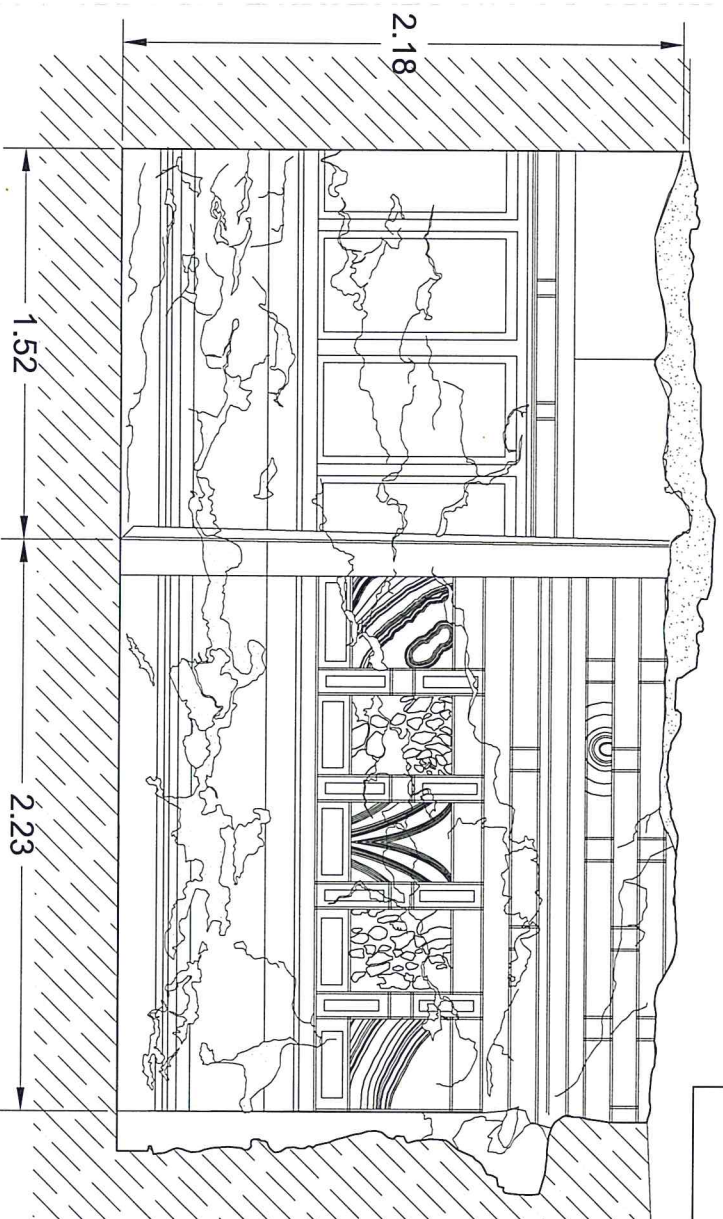
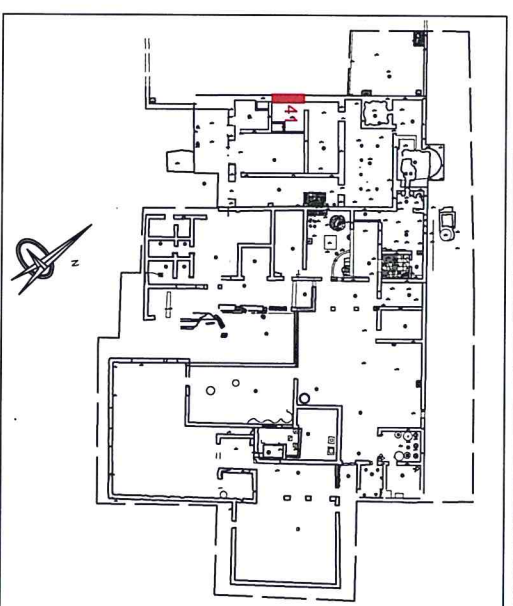

SCHEDA D'INTERVENTO				
TAGLI / DISTACCHI				
AMBIENTE 42 PARETE SUD				
DESC.ART.	UM	SUPERFICIE	PREZZO UNITARIO	IMPORTO
045097a	mq	7,63	€ 435,35	€ 3 321,72
045095	mq	7,01	€ 377,98	€ 2 649,64
045096.b	mq	7,01	€ 144,54	€ 1 013,23
045028.a	mq	7,01	€ 82,66	€ 579,45
045054.b	mq	7,01	€ 577,70	€ 4 049,68
045031.b	mq	7,01	€ 173,03	€ 1 212,94
045077.b	mq	7,01	€ 123,38	€ 864,89
045083.b	mq	7,01	€ 303,63	€ 2 128,45
045085.d	mq	7,01	€ 324,55	€ 2 275,10
045090.b	mq	7,01	€ 24,92	€ 174,69
TOTALE INTERVENTO				€ 18 269,77

Terzigno Villa 6

Ambiente 42 parete Sud

SUPERFICIE PANNELLO :MQ 7.63

SUPERFICIE AFFRESCO :MQ 7.01

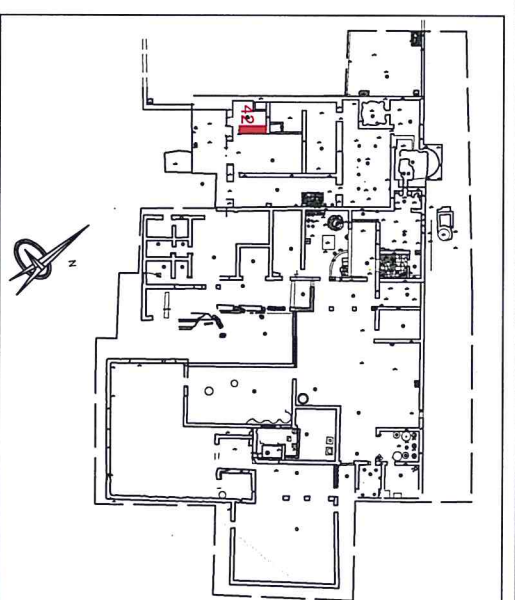

SCHEDA D'INTERVENTO				
TAGLI / DISTACCHI				
AMBIENTE 42 PARETE OVEST				
DESC.ART.	UM	SUPERFICIE	PREZZO UNITARIO	IMPORTO
045097a	mq	4,00	€ 435,35	€ 1 741,40
045095	mq	3,84	€ 377,98	€ 1 451,44
045096.b	mq	3,84	€ 144,54	€ 555,03
045028.a	mq	3,84	€ 82,66	€ 317,41
045054.b	mq	3,84	€ 577,70	€ 2 218,37
045031.b	mq	3,84	€ 173,03	€ 664,44
045077.b	mq	3,84	€ 123,38	€ 473,78
045083.b	mq	3,84	€ 303,63	€ 1 165,94
045085.d	mq	3,84	€ 324,55	€ 1 246,27
045090.b	mq	3,84	€ 24,92	€ 95,69
TOTALE INTERVENTO				€ 9 929,78

Terzigno Villa 6

Ambiente 42 parete Ovest

SUPERFICIE PANNELLO : MQ 4,00

SUPERFICIE AFFRESCO : MQ 3,84

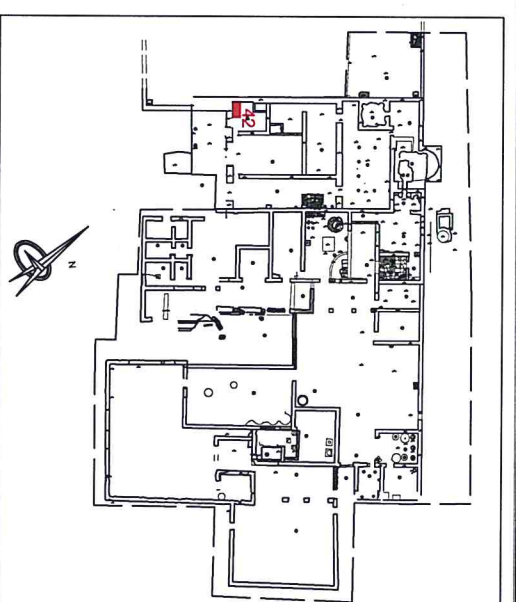
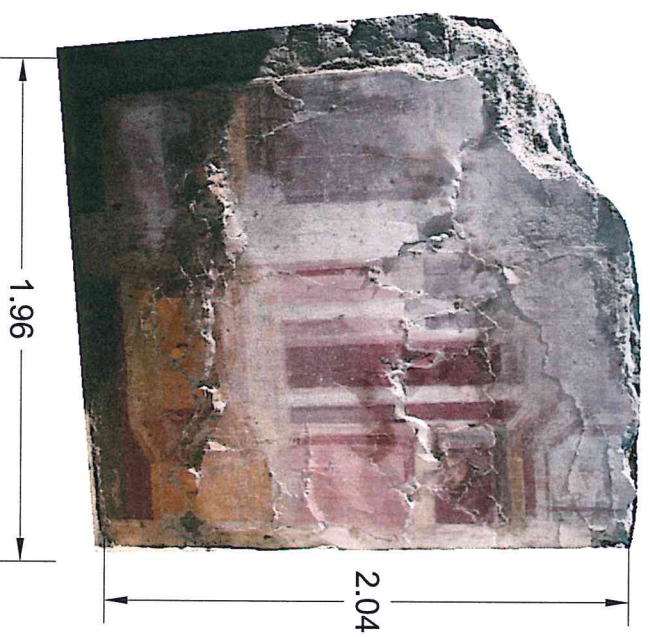

SCHEDA D'INTERVENTO				
TAGLI / DISTACCHI				
AMBIENTE 42 PARETE NORD				
DESC.ART.	UM	SUPERFICIE	PREZZO UNITARIO	IMPORTO
045097a	mq	5,52	€ 435,35	€ 2 403,13
045095	mq	5,52	€ 377,98	€ 2 086,45
045096.b	mq	5,52	€ 144,54	€ 797,86
045028.a	mq	5,52	€ 82,66	€ 456,28
045054.b	mq	5,52	€ 577,70	€ 3 188,90
045031.b	mq	5,52	€ 173,03	€ 955,13
045077.b	mq	5,52	€ 123,38	€ 681,06
045083.b	mq	5,52	€ 303,63	€ 1 676,04
045085.d	mq	5,52	€ 324,55	€ 1 791,52
045090.b	mq	5,52	€ 24,92	€ 137,56
TOTALE INTERVENTO				€ 14 173,92

Terzigno Villa 6

Ambiente 42 parete Nord

SUPERFICIE PANNELLO: MQ 5,52

SUPERFICIE AFFRESCO . MQ 5.52

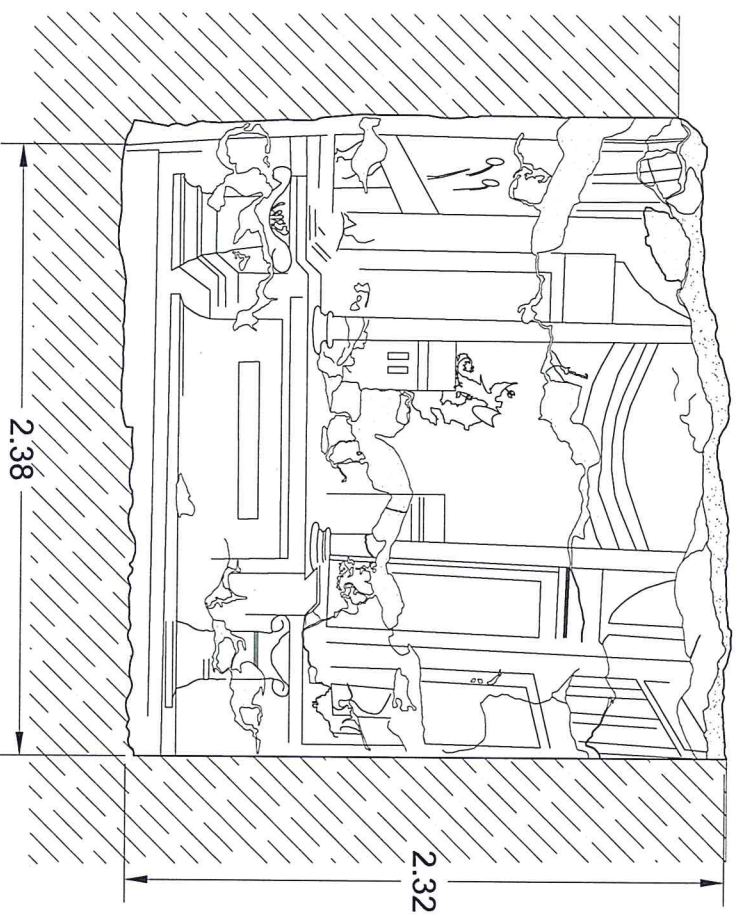
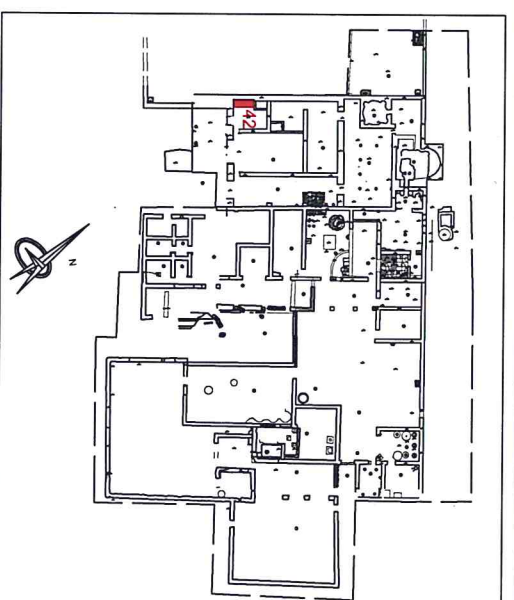

SCHEDA D'INTERVENTO				
TAGLI / DISTACCHI				
AMBIENTE 42 PARETE EST ALCOVA EST				
DESC.ART.	UM	SUPERFICIE	PREZZO UNITARIO	IMPORTO
045097a	mq	4,23	€ 435,35	€ 1 841,53
045095	mq	3,86	€ 377,98	€ 1 459,00
045096.b	mq	3,86	€ 144,54	€ 557,92
045028.a	mq	3,86	€ 82,66	€ 319,07
045054.b	mq	3,86	€ 577,70	€ 2 229,92
045031.b	mq	3,86	€ 173,03	€ 667,90
045077.b	mq	3,86	€ 123,38	€ 476,25
045083.b	mq	3,86	€ 303,63	€ 1 172,01
045085.d	mq	3,86	€ 324,55	€ 1 252,76
045090.b	mq	3,86	€ 24,92	€ 96,19
TOTALE INTERVENTO				€ 10 072,56

Terzigno Villa 6

Ambiente 42 parete Est
alcova Est

SUPERFICIE PANNELLO :MQ 4.23

SUPERFICIE AFFRESCO :MQ 3.86

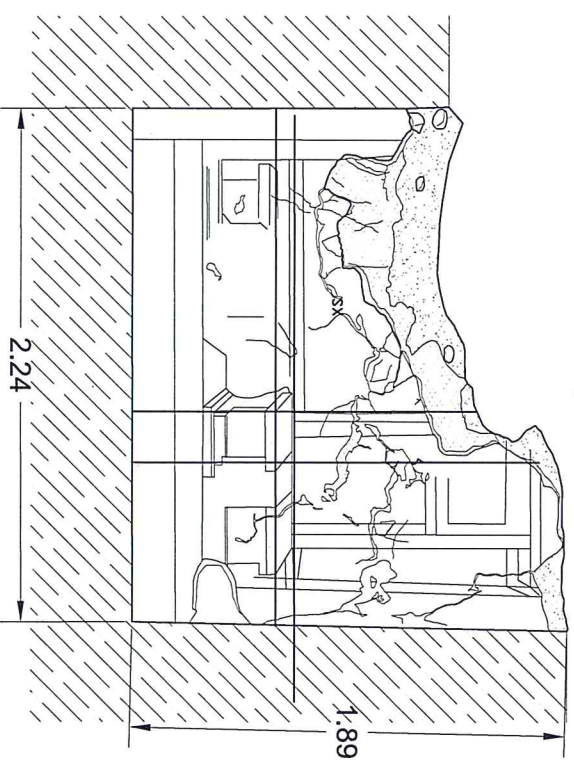
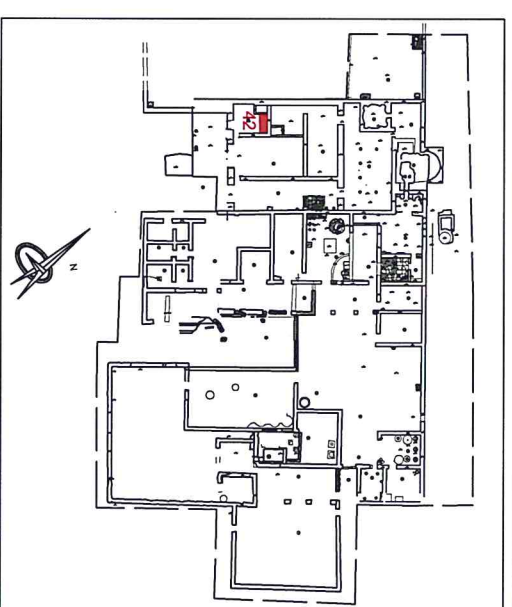

SCHEDA D'INTERVENTO				
TAGLI / DISTACCHI				
AMBIENTE 42 PARETE NORD ALCOVA EST				
DESC.ART.	UM	SUPERFICIE	PREZZO UNITARIO	IMPORTO
045097a	mq	1,83	€ 435,35	€ 796,69
045095	mq	1,41	€ 377,98	€ 532,95
045096.b	mq	1,41	€ 144,54	€ 203,80
045028.a	mq	1,41	€ 82,66	€ 116,55
045054.b	mq	1,41	€ 577,70	€ 814,56
045031.b	mq	1,41	€ 173,03	€ 243,97
045077.b	mq	1,41	€ 123,38	€ 173,97
045083.b	mq	1,41	€ 303,63	€ 428,12
045085.d	mq	1,41	€ 324,55	€ 457,62
045090.b	mq	1,41	€ 24,92	€ 35,14
TOTALE INTERVENTO				€ 3 803,36

Terzigno Villa 6

Ambiente 42 parete Nord

alcova Est

SUPERFICIE PANNELLO: MQ 1.83

SUPERFICIE AFFRESCO : MQ 1.41

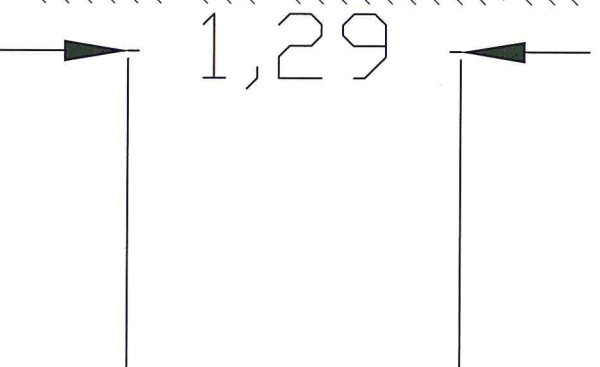
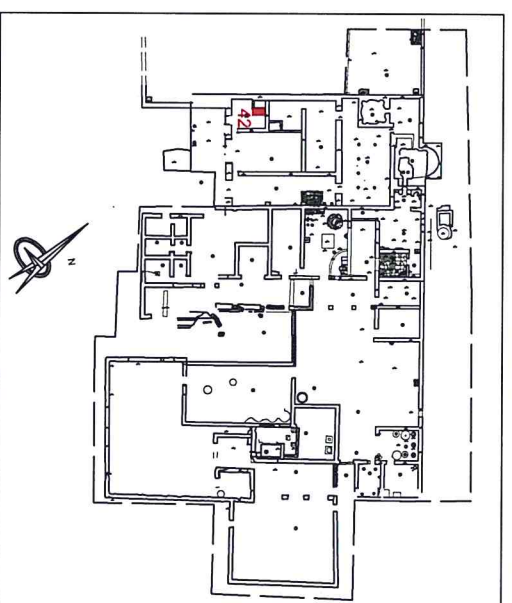
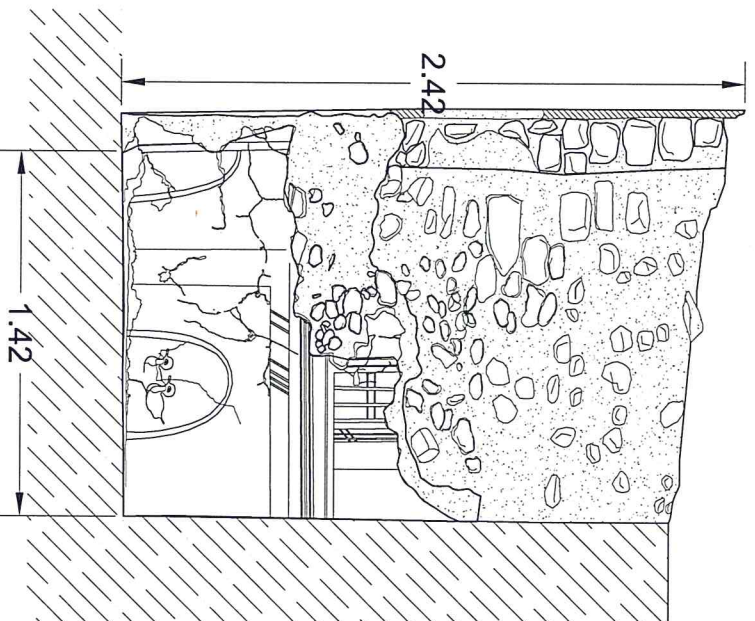
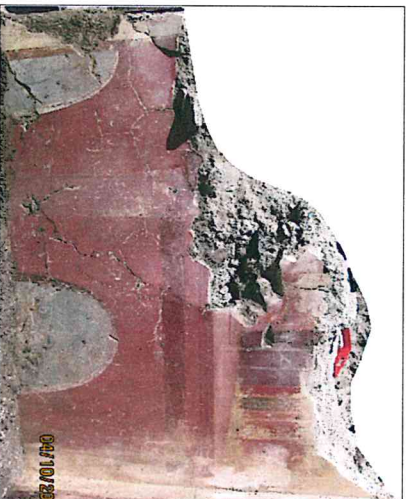

SCHEDA D'INTERVENTO				
TAGLI / DISTACCHI				
AMBIENTE 42 PARETE EST ALCOVA NORD				
DESC.ART.	UM	SUPERFICIE	PREZZO UNITARIO	IMPORTO
045097a	mq	1,27	€ 435,35	€ 552,89
045095	mq	0,98	€ 377,98	€ 370,42
045096.b	mq	0,98	€ 144,54	€ 141,65
045028.a	mq	0,98	€ 82,66	€ 81,01
045054.b	mq	0,98	€ 577,70	€ 566,15
045031.b	mq	0,98	€ 173,03	€ 169,57
045077.b	mq	0,98	€ 123,38	€ 120,91
045083.b	mq	0,98	€ 303,63	€ 297,56
045085.d	mq	0,98	€ 324,55	€ 318,06
045090.b	mq	0,98	€ 24,92	€ 24,42
TOTALE INTERVENTO				€ 2 642,64

Terzigno Villa 6

Ambiente 42 parete Est

alcova Nord

SUPERFICIE PANNELLO :MQ 1.27

SUPERFICIE AFFRESCO :MQ 0.98

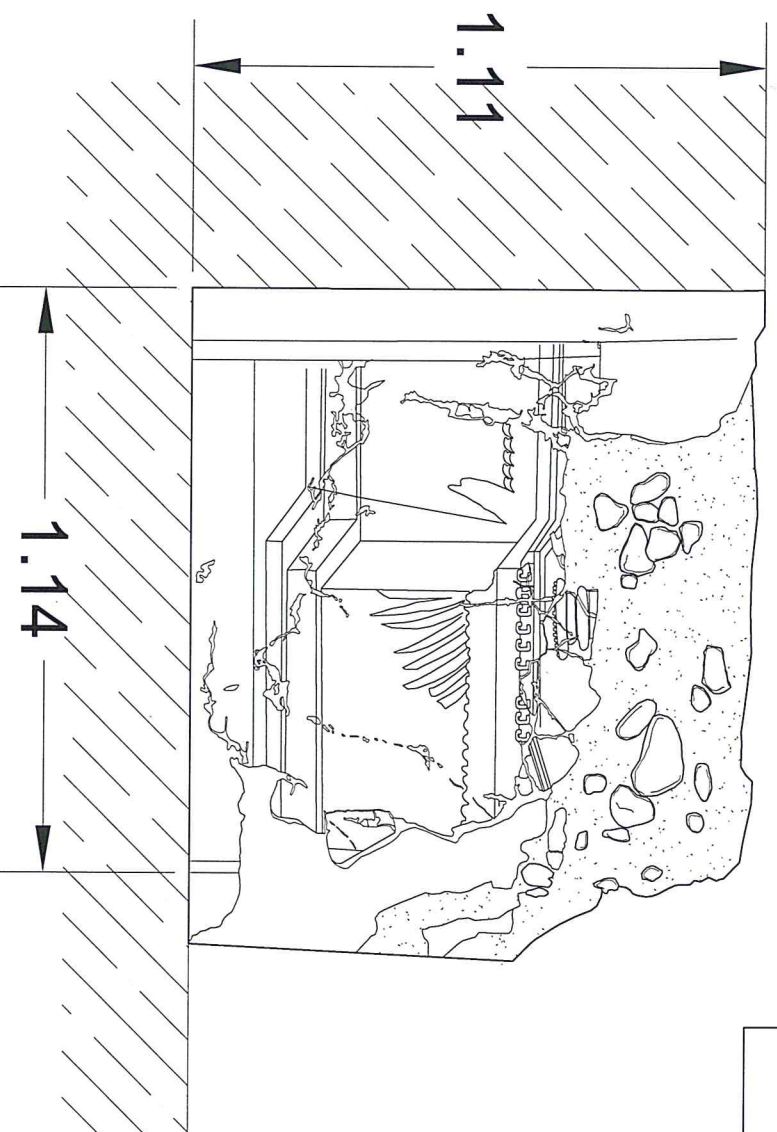
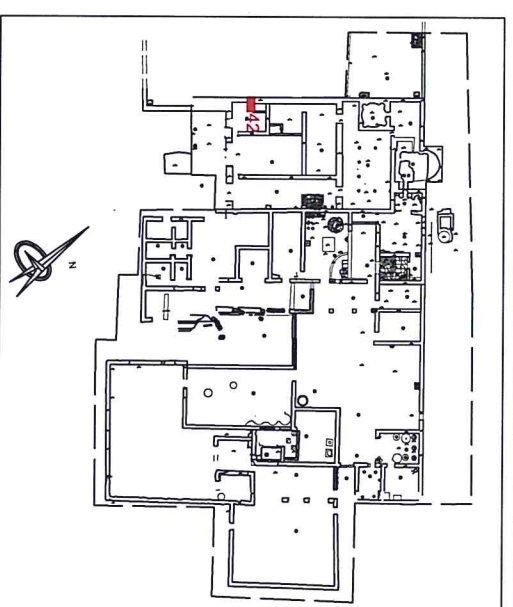

SCHEDA D'INTERVENTO				
TAGLI / DISTACCHI				
AMBIENTE 25 PARETE OVEST				
DESC.ART.	UM	SUPERFICIE	PREZZO UNITARIO	IMPORTO
045097a	mq	20,89	€ 435,35	€ 9 094,46
045095	mq	17,57	€ 377,98	€ 6 641,11
045096.b	mq	17,57	€ 144,54	€ 2 539,57
045028.a	mq	17,57	€ 82,66	€ 1 452,34
045054.b	mq	17,57	€ 577,70	€ 10 150,19
045031.b	mq	17,57	€ 173,03	€ 3 040,14
045077.b	mq	17,57	€ 123,38	€ 2 167,79
045083.b	mq	17,57	€ 303,63	€ 5 334,78
045085.d	mq	17,57	€ 324,55	€ 5 702,34
045090.b	mq	17,57	€ 24,92	€ 437,84
TOTALE INTERVENTO				€ 46 560,55

Terzigno Villa 6

Ambiente 25 parete Ovest

SUPERFICIE PANNELLO: 20.89

SUPERFICIE AFFRESCO : MQ 17.57

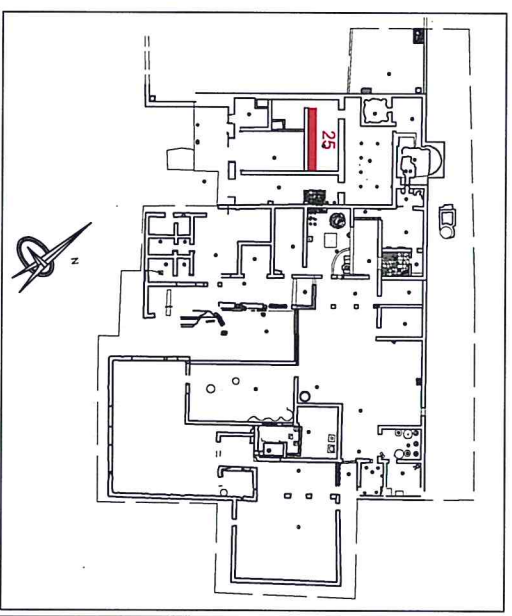
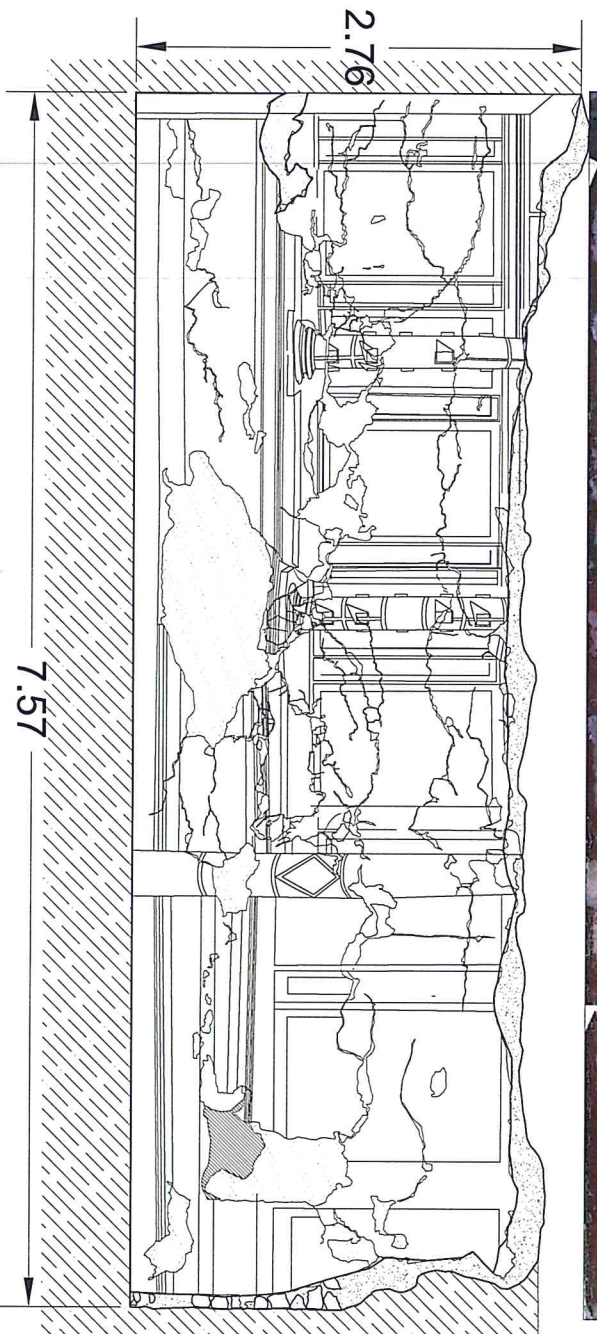

SCHEDA D'INTERVENTO				
TAGLI / DISTACCHI				
AMBIENTE 25 PARETE SUD				
DESC.ART.	UM	SUPERFICIE	PREZZO UNITARIO	IMPORTO
045097a	mq	8,56	€ 435,35	€ 3 726,60
045095	mq	7,47	€ 377,98	€ 2 823,51
045096.b	mq	7,47	€ 144,54	€ 1 079,71
045028.a	mq	7,47	€ 82,66	€ 617,47
045054.b	mq	7,47	€ 577,70	€ 4 315,42
045031.b	mq	7,47	€ 173,03	€ 1 292,53
045077.b	mq	7,47	€ 123,38	€ 921,65
045083.b	mq	7,47	€ 303,63	€ 2 268,12
045085.d	mq	7,47	€ 324,55	€ 2 424,39
045090.b	mq	7,47	€ 24,92	€ 186,15
TOTALE INTERVENTO				€ 19 655,55

Terzigno Villa 6

Ambiente 25 parete Sud

SUPERFICIE PANNELLO: MQ 8.56

SUPERFICIE AFFRESCO: MQ 7.47

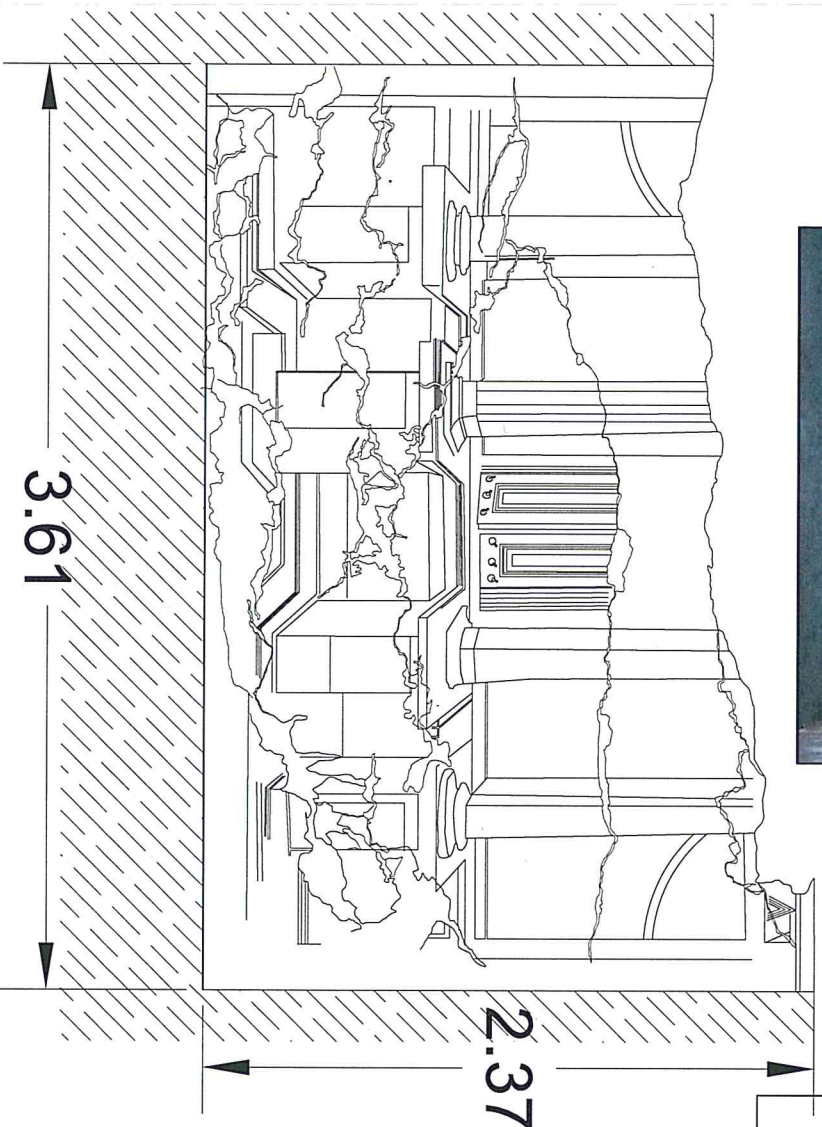
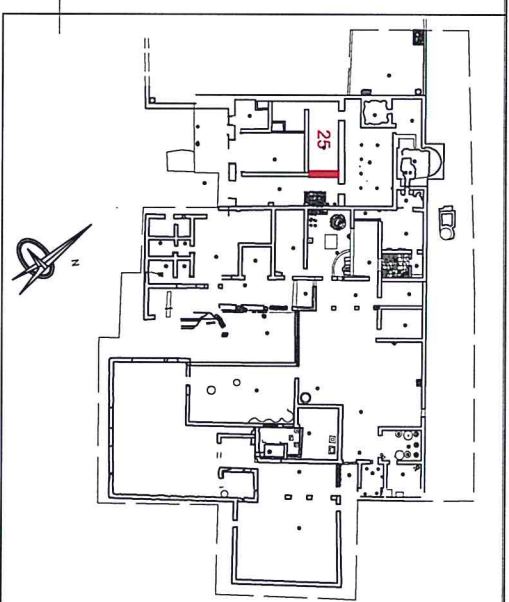

SCHEDA D'INTERVENTO				
TAGLI / DISTACCHI				
AMBIENTE 31 PARETE SUD				
DESC.ART.	UM	SUPERFICIE	PREZZO UNITARIO	IMPORTO
045097a	mq	1,50	€ 435,35	€ 653,03
045095	mq	1,50	€ 377,98	€ 566,97
045096.b	mq	1,50	€ 144,54	€ 216,81
045028.a	mq	1,50	€ 82,66	€ 123,99
045054.b	mq	1,50	€ 577,70	€ 866,55
045031.b	mq	1,50	€ 173,03	€ 259,55
045077.b	mq	1,50	€ 123,38	€ 185,07
045083.b	mq	1,50	€ 303,63	€ 455,45
045085.d	mq	1,50	€ 324,55	€ 486,83
045090.b	mq	1,50	€ 24,92	€ 37,38
TOTALE INTERVENTO				€ 3 851,61

Terzigno Villa 6

Ambiente 31 parete Sud

SUPERFICIE PANNELLO : MQ 1,50

SUPERFICIE AFFRESCO : MQ 1,50

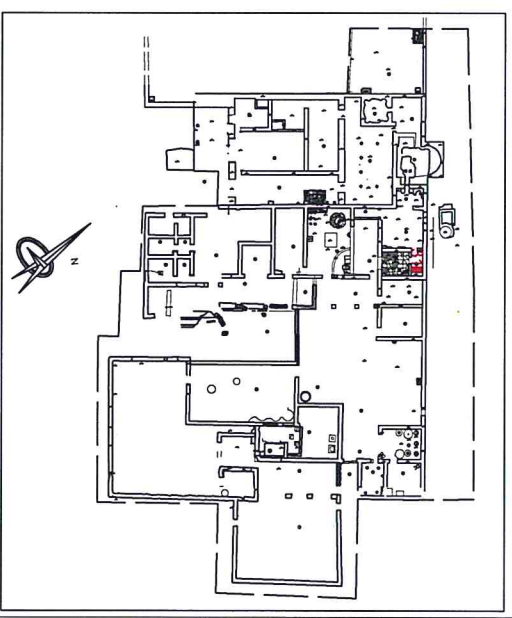

SCHEDA D'INTERVENTO				
TAGLI / DISTACCHI				
AMBIENTE 26 PARETE NORD				
DESC.ART.	UM	SUPERFICIE	PREZZO UNITARIO	IMPORTO
045097a	mq	3,72	€ 435,35	€ 1 619,50
045095	mq	2,44	€ 377,98	€ 922,27
045096.b	mq	2,44	€ 144,54	€ 352,68
045028.a	mq	2,44	€ 82,66	€ 201,69
045054.b	mq	2,44	€ 577,70	€ 1 409,59
045031.b	mq	2,44	€ 173,03	€ 422,19
045077.b	mq	2,44	€ 123,38	€ 301,05
045083.b	mq	2,44	€ 303,63	€ 740,86
045085.d	mq	2,44	€ 324,55	€ 791,90
045090.b	mq	2,44	€ 24,92	€ 60,80
TOTALE INTERVENTO				€ 6 822,53

Terzigno Villa 6

Ambiente 26 parete Nord

SUPERFICIE PANNELLO : MQ 3.72
SUPERFICIE AFFRESCO : MQ 2.44

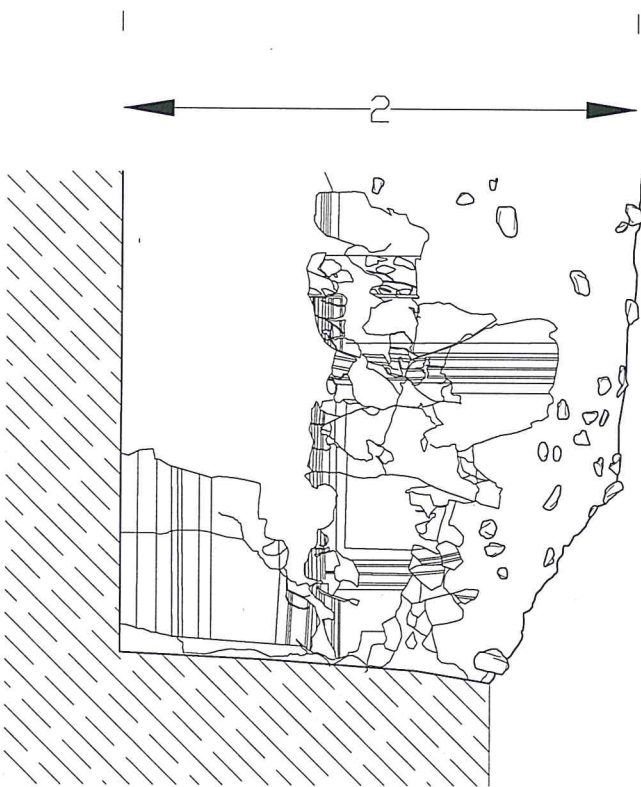
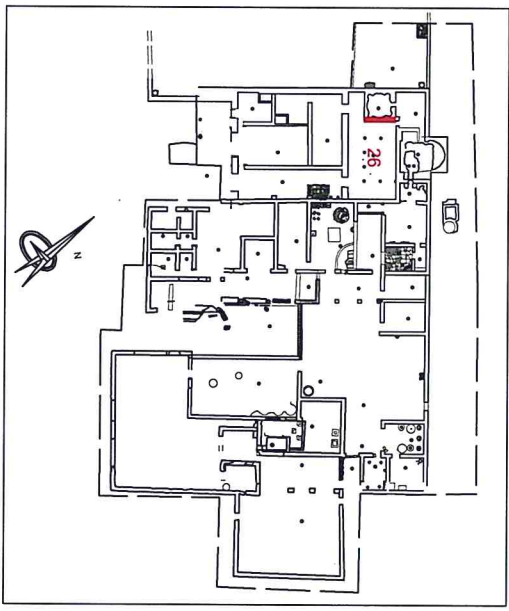

1,86

SCHEDA D'INTERVENTO				
TAGLI / DISTACCHI				
AMBIENTE 26 PARETE OVEST				
DESC.ART.	UM	SUPERFICIE	PREZZO UNITARIO	IMPORTO
045097a	mq	2,47	€ 435,35	€ 1 075,31
045095	mq	1,89	€ 377,98	€ 714,38
045096.b	mq	1,89	€ 144,54	€ 273,18
045028.a	mq	1,89	€ 82,66	€ 156,23
045054.b	mq	1,89	€ 577,70	€ 1 091,85
045031.b	mq	1,89	€ 173,03	€ 327,03
045077.b	mq	1,89	€ 123,38	€ 233,19
045083.b	mq	1,89	€ 303,63	€ 573,86
045085.d	mq	1,89	€ 324,55	€ 613,40
045090.b	mq	1,89	€ 24,92	€ 47,10
TOTALE INTERVENTO				€ 5 105,53

Terzigno Villa 6

Ambiente 26 parete Ovest

SUPERFICIE PANNELLO :MQ 2.47

SUPERFICIE AFFRESCO :MQ 1.89

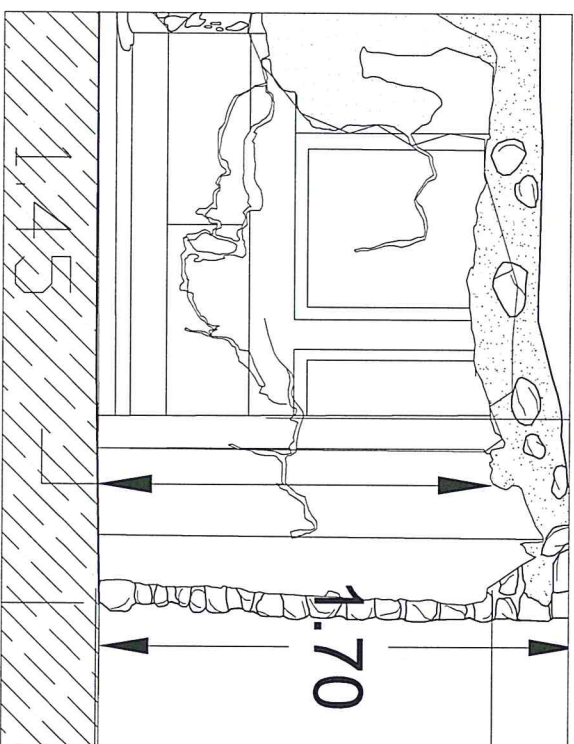
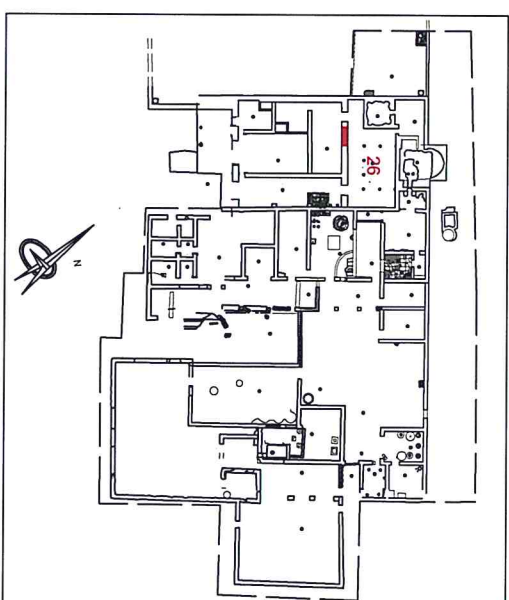

SCHEDA D'INTERVENTO				
TAGLI / DISTACCHI				
AMBIENTE 26b PARETE EST				
DESC.ART.	UM	SUPERFICIE	PREZZO UNITARIO	IMPORTO
045097a	mq	5,45	€ 435,35	€ 2 372,66
045095	mq	3,03	€ 377,98	€ 1 145,28
045096.b	mq	3,03	€ 144,54	€ 437,96
045028.a	mq	3,03	€ 82,66	€ 250,46
045054.b	mq	3,03	€ 577,70	€ 1 750,43
045031.b	mq	3,03	€ 173,03	€ 524,28
045077.b	mq	3,03	€ 123,38	€ 373,84
045083.b	mq	3,03	€ 303,63	€ 920,00
045085.d	mq	3,03	€ 324,55	€ 983,39
045090.b	mq	3,03	€ 24,92	€ 75,51
TOTALE INTERVENTO				€ 8 833,80

Terzigno Villa 6

Ambiente 26b parete Est

SUPERFICIE PANNELLO :MQ 5.45

SUPERFICIE AFFRESCO :MQ 3.03

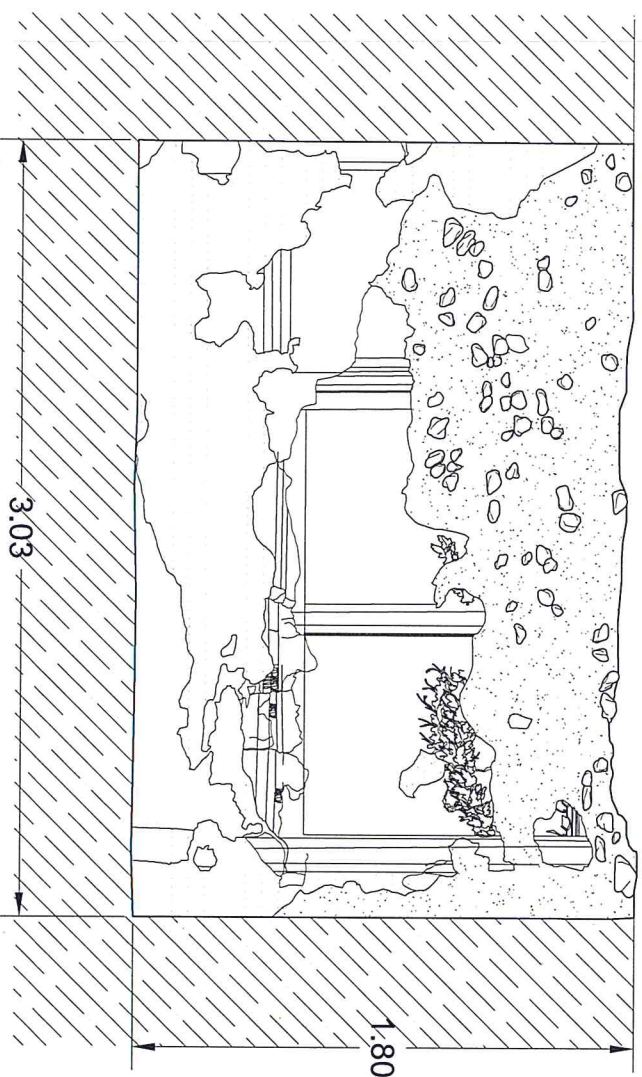
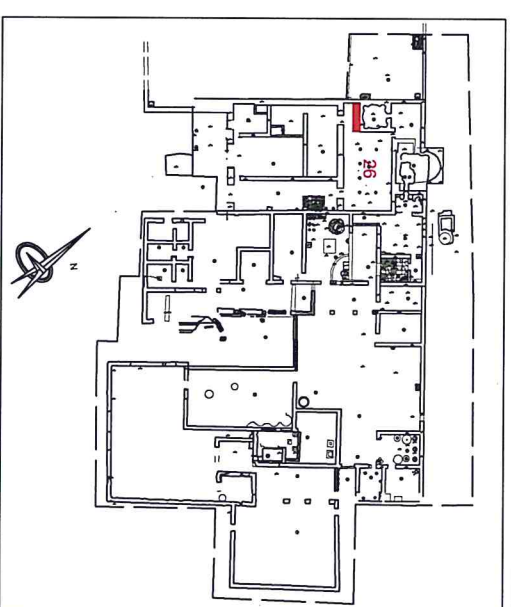

SCHEDA D'INTERVENTO				
TAGLI / DISTACCHI				
AMBIENTE 28 PARETE EST				
DESC.ART.	UM	SUPERFICIE	PREZZO UNITARIO	IMPORTO
045097a	mq	0,93	€ 435,35	€ 404,88
045095	mq	0,88	€ 377,98	€ 332,62
045096.b	mq	0,88	€ 144,54	€ 127,20
045028.a	mq	0,88	€ 82,66	€ 72,74
045054.b	mq	0,88	€ 577,70	€ 508,38
045031.b	mq	0,88	€ 173,03	€ 152,27
045077.b	mq	0,88	€ 123,38	€ 108,57
045083.b	mq	0,88	€ 303,63	€ 267,19
045085.d	mq	0,88	€ 324,55	€ 285,60
045090.b	mq	0,88	€ 24,92	€ 21,93
TOTALE INTERVENTO				€ 2 281,38

Terzigno Villa 6

Ambiente 28 parete Est

SUPERFICIE PANNELLO :MQ 0.93

SUPERFICIE AFFRESCO :MQ 0.88

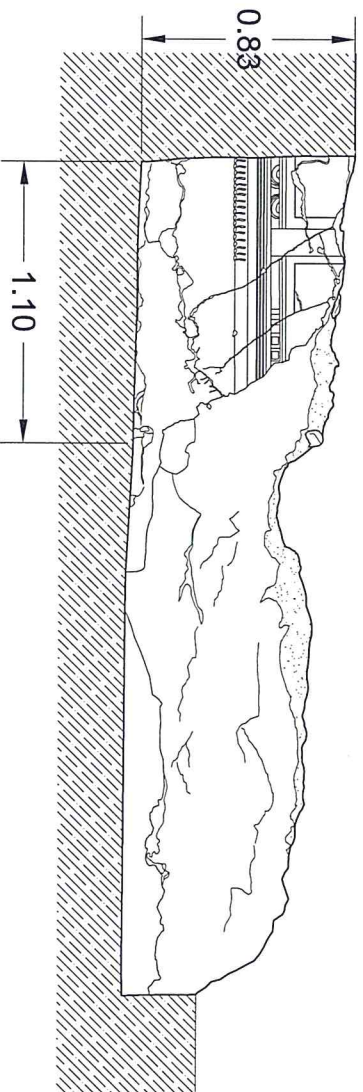
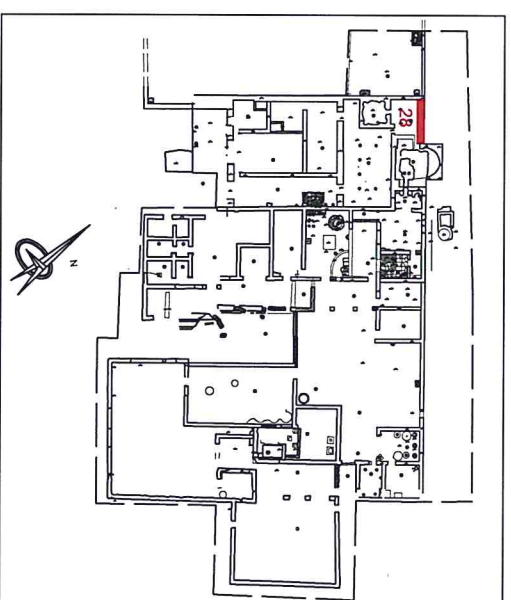

SCHEDA D'INTERVENTO				
TAGLI / DISTACCHI				
AMBIENTE 28 PARETE OVEST PILASTRO FACCIA NORD				
DESC.ART.	UM	SUPERFICIE	PREZZO UNITARIO	IMPORTO
045097a	mq	0,50	€ 435,35	€ 217,68
045095	mq	0,48	€ 377,98	€ 181,43
045096.b	mq	0,48	€ 144,54	€ 69,38
045028.a	mq	0,48	€ 82,66	€ 39,68
045054.b	mq	0,48	€ 577,70	€ 277,30
045031.b	mq	0,48	€ 173,03	€ 83,05
045077.b	mq	0,48	€ 123,38	€ 59,22
045083.b	mq	0,48	€ 303,63	€ 145,74
045085.d	mq	0,48	€ 324,55	€ 155,78
045090.b	mq	0,48	€ 24,92	€ 11,96
TOTALE INTERVENTO				€ 1 241,22

Terzigno Villa 6

Ambiente 28 parete Ovest pilastro faccia Nord

SUPERFICIE PANNELLO :MQ 0.50

SUPERFICIE AFFRESCO :MQ 0.48

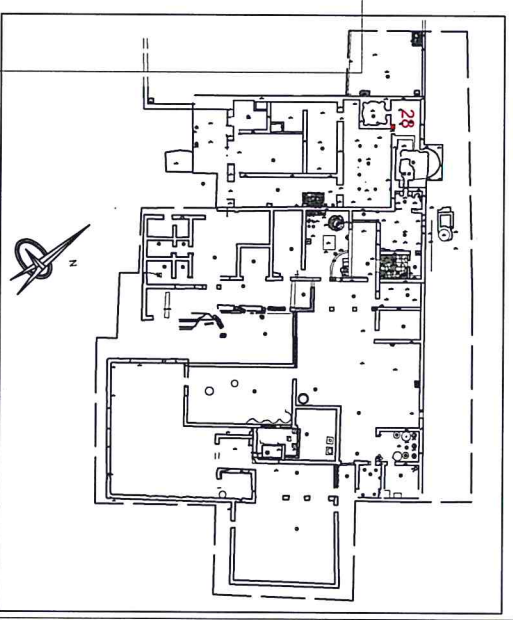
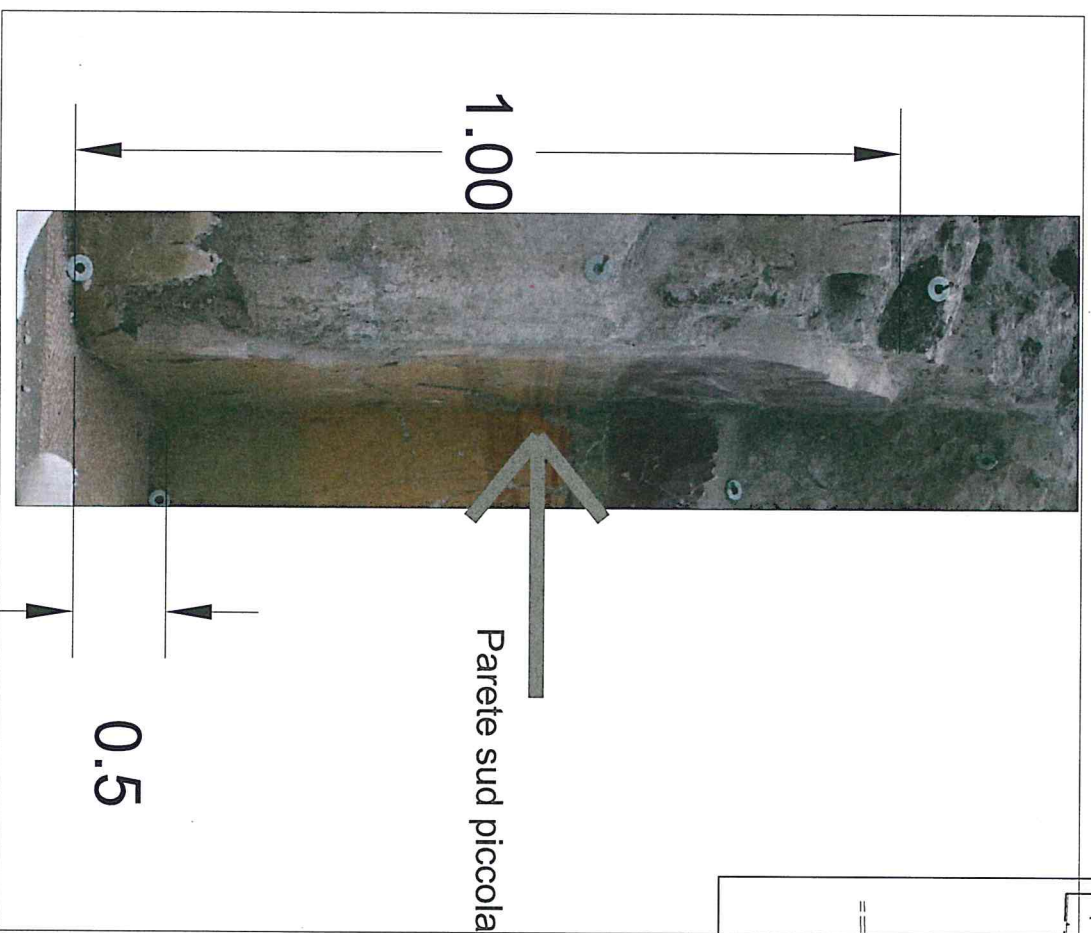

SCHEDA D'INTERVENTO				
TAGLI / DISTACCHI				
AMBIENTE 28 PARETE SUD				
DESC.ART.	UM	SUPERFICIE	PREZZO UNITARIO	IMPORTO
045097a	mq	0,73	€ 435,35	€ 317,81
045095	mq	0,50	€ 377,98	€ 188,99
045096.b	mq	0,50	€ 144,54	€ 72,27
045028.a	mq	0,50	€ 82,66	€ 41,33
045054.b	mq	0,50	€ 577,70	€ 288,85
045031.b	mq	0,50	€ 173,03	€ 86,52
045077.b	mq	0,50	€ 123,38	€ 61,69
045083.b	mq	0,50	€ 303,63	€ 151,82
045085.d	mq	0,50	€ 324,55	€ 162,28
045090.b	mq	0,50	€ 24,92	€ 12,46
TOTALE INTERVENTO				€ 1 384,00

Terzigno Villa 6

Ambiente 28 parete Sud

SUPERFICIE PANNELLO :MQ 0.73

SUPERFICIE AFFRESCO :MQ 0.50

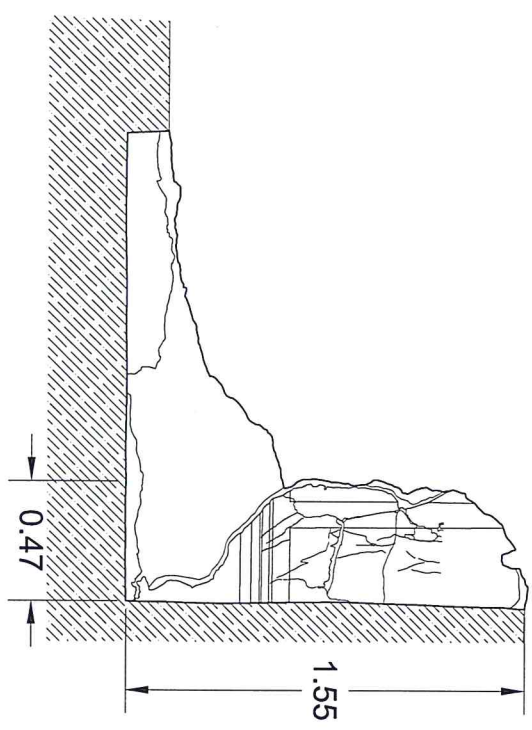
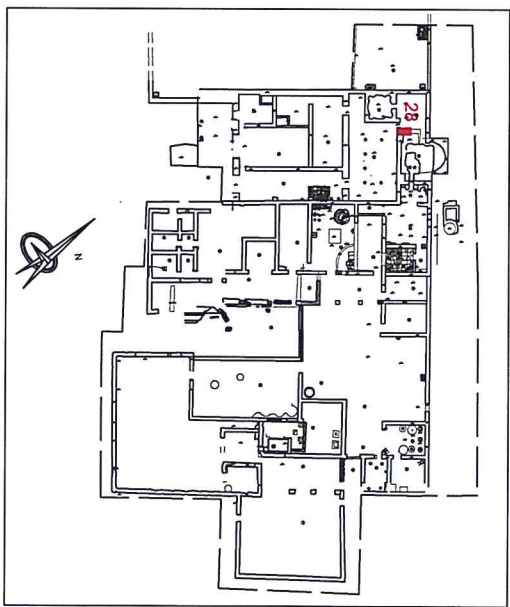
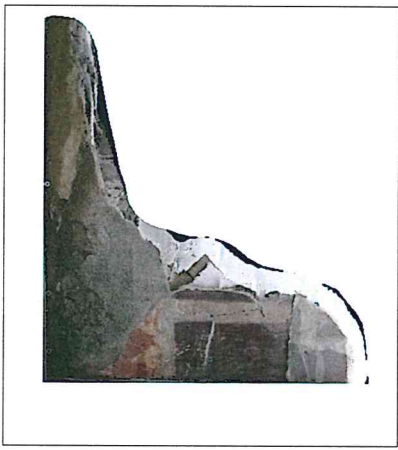

SCHEDA D'INTERVENTO				
TAGLI / DISTACCHI				
AMBIENTE 28 PARETE OVEST				
DESC.ART.	UM	SUPERFICIE	PREZZO UNITARIO	IMPORTO
045097a	mq	1,93	€ 435,35	€ 840,23
045095	mq	1,48	€ 377,98	€ 559,41
045096.b	mq	1,48	€ 144,54	€ 213,92
045028.a	mq	1,48	€ 82,66	€ 122,34
045054.b	mq	1,48	€ 577,70	€ 855,00
045031.b	mq	1,48	€ 173,03	€ 256,08
045077.b	mq	1,48	€ 123,38	€ 182,60
045083.b	mq	1,48	€ 303,63	€ 449,37
045085.d	mq	1,48	€ 324,55	€ 480,33
045090.b	mq	1,48	€ 24,92	€ 36,88
TOTALE INTERVENTO				€ 3 996,16

Terzigno Villa 6

Ambiente 28 parete Ovest

Pilastro faccia nord

SUPERFICIE PANNELLO :MQ 1.93

SUPERFICIE AFFRESCO :MQ 1.48

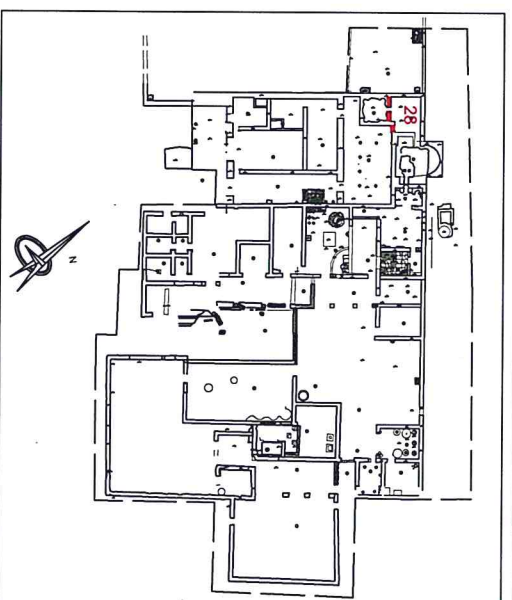

SCHEDA D'INTERVENTO				
TAGLI / DISTACCHI				
AMBIENTE 28 PARETE NORD				
DESC.ART.	UM	SUPERFICIE	PREZZO UNITARIO	IMPORTO
045097a	mq	3,21	€ 435,35	€ 1 397,47
045095	mq	1,03	€ 377,98	€ 389,32
045096.b	mq	1,03	€ 144,54	€ 148,88
045028.a	mq	1,03	€ 82,66	€ 85,14
045054.b	mq	1,03	€ 577,70	€ 595,03
045031.b	mq	1,03	€ 173,03	€ 178,22
045077.b	mq	1,03	€ 123,38	€ 127,08
045083.b	mq	1,03	€ 303,63	€ 312,74
045085.d	mq	1,03	€ 324,55	€ 334,29
045090.b	mq	1,03	€ 24,92	€ 25,67
TOTALE INTERVENTO				€ 3 593,84

Terzigno Villa 6

Ambiente 28 parete Nord

SUPERFICIE PANNELLO :MQ 3.21

SUPERFICIE AFFRESCO :MQ 1.03

